

MP short length RAL 3002 5012

GALVANIZED AND POWDER COATED STRUCTURE / STRUTTURA ZINCATA E VERNICIATA

ø 200 mm
drum/tamburo

connection hose included
tubo di collegamento incluso

Quality components
for oxidation resistance
*Componenti di qualità
per resistenza all'ossidazione*



EN Automatic hose reels suitable for the distribution of compressed air for professional use. They are supplied complete with distribution and connection polyurethane hoses which are 1 m long and reinforced with a textile braid. The incorporated revolving bracket allows to orientate the hose reels in order to follow the hose direction. They can also be used as balancers for pneumatic tools.

FR Enrouleurs automatiques utilisés pour la distribution d'air comprimé pour usage professionnel. Tous livrés avec tuyau de distribution et de connexion de 1 m en polyuréthane renforcé avec tresse textile. Le support pivotant incorporé permet d'orienter

l'enrouleur selon la direction d'utilisation du tuyau. Utilisation possible comme équilibreur pour alimenter les outils pneumatiques.

DE Autom. Industrie Druckluftschlauchaufroller. Inkl. Abgabe- und 1m Verbindungsschlauch aus Polyurethan, cord amriert. Mit Schwenkkonsole zur Orientierung in Richtung des Benutzers. Möglicher Einsatz an pneumatischen Werkzeugen.

ES Enrolladores automáticos preparados para la distribución de aire comprimido con uso profesional. Se suministran equipados de manguera de distribución y de conexión con

1 m. de longitud de poliuretano reforzada con malla textil. El soporte giratorio incorporado permite la orientación según la dirección de uso de la manguera. Es posible utilizar el enrollador como equilibrador para la alimentación de herramientas neumáticas.

IT Avvolgitubo automatici adatti per la distribuzione di aria compressa ad uso professionale. Completi di tubo di distribuzione e di collegamento lunghezza 1 m in poliuretano rinforzato con treccia tessile. Il supporto girevole incorporato permette l'orientamento secondo la direzione di utilizzo del tubo. Possibile utilizzo come bilanciatore per l'alimentazione di utensili pneumatici.

Dimensions (mm) / Dimensioni (mm)

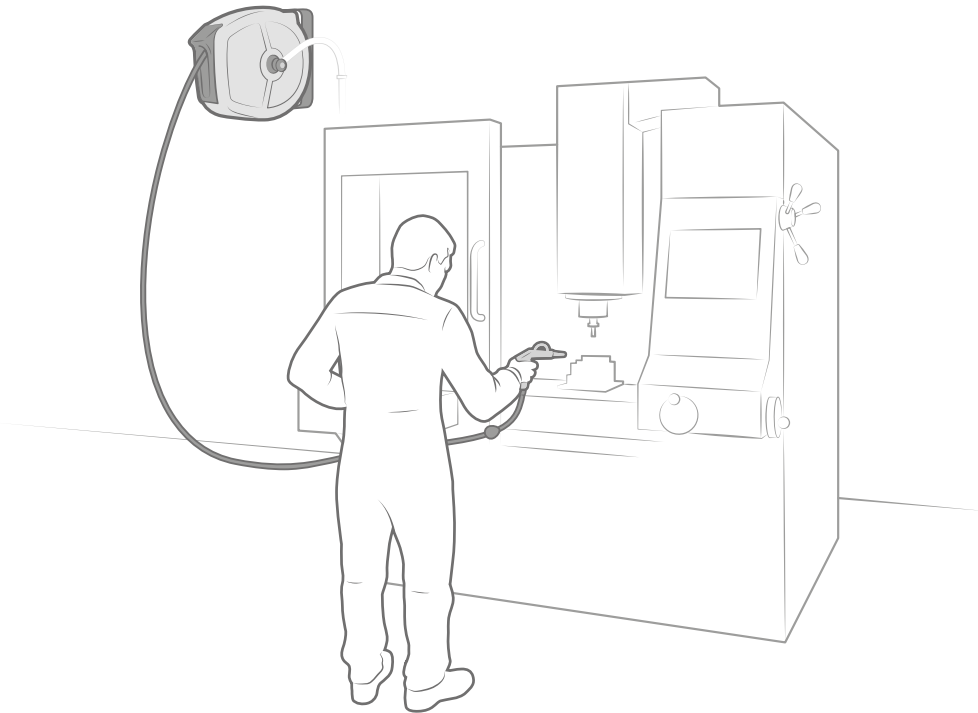
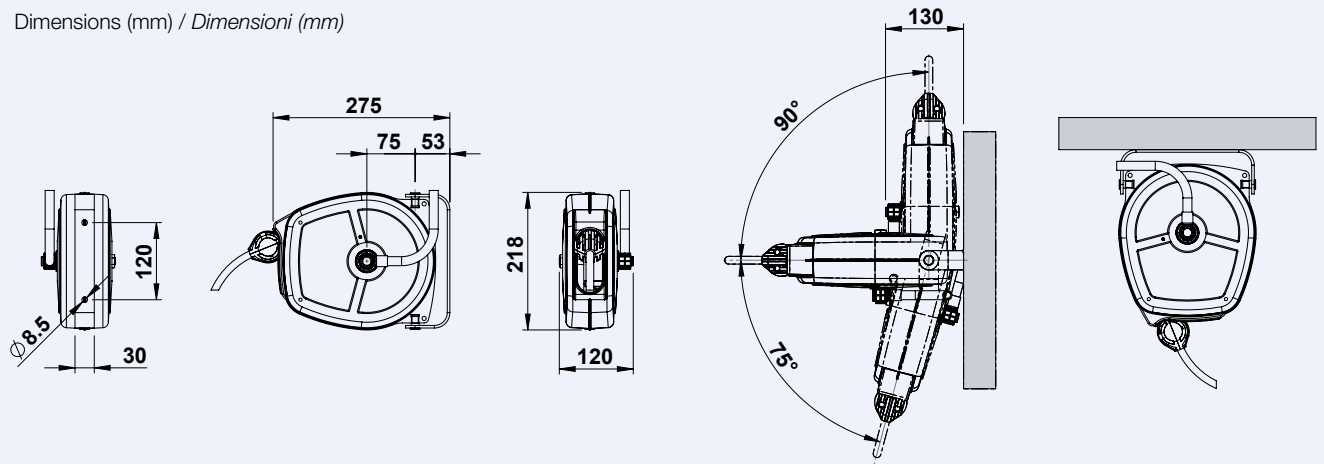

Hose reels model MP with hose / Avvolgitubo modello MP completi di tubo

Fluid Fluido	Pressure - Hose Pressione - Tubo	Code Codice	Inlet (mm) Entrata (mm)	Outlet (Bsp) Uscita (Gas)	Hose diam. Tubo diam.	Hose length Lungh. Tubo	Weight (kg) Peso (kg)
Air/Aria	20 bar/290 psi Polyurethane Poliuretano	MP200606	Ø 8	1/4" M	6,5 x 10	6 m/20 ft	3
		MP200805	Ø 8	1/4" M	8 x 11	5 m/16 ft	3
		MP201003	Ø 10	3/8" M	10 x 14	3 m/10 ft	3